



**NP9-12  
NP9-12FR**

*Sealed Rechargeable  
Lead-Acid Battery*

**12V, 9.0Ah**

**Specifications**

- **NOMINAL VOLTAGE:** 12V
- **NOMINAL CAPACITY:**
  - 20 hr. rate to 10.5V 0.45A to 10.5V 9.0Ah
  - 10 hr. rate to 10.5V 0.85A to 10.5V 8.5Ah
  - 5 hr. rate to 10.2V 1.53A to 10.2V 7.65Ah
  - 15 min. rate to 1.67Vpc 36
- **ENGINE START SPECIFICATIONS:**
  - CCA 30 seconds at 0°F 110A
  - CA 30 seconds at 32°F 175A
- **WEIGHT (approx.):** 6.15 pounds (2.80 kgs.)
- **ENERGY DENSITY (20 hr. rate):** 113.9 WH/litre
- **SPECIFIC ENERGY (20 hr. rate):** 17.7 WH/litre
- **INTERNAL RESISTANCE OF CHARGED BATTERY:** 14.5 milliohms (approx.)
- **MAXIMUM SHORT-DURATION DISCHARGE CURRENT:** 135 amperes
- **OPERATING TEMPERATURE RANGE:**
  - CHARGE -15°C to 40°C (5°F to 104°F)
  - DISCHARGE -15°C to 50°C (5°F to 122°F)
  - STORAGE -15°C to 40°C (5°F to 104°F)
- **CHARGE RETENTION (shelf life) at 20°C (68°F):**
  - 1 month 98%
  - 3 months 94%
  - 6 months 85%
- **LIFE EXPECTANCY:**
  - STANDBY USE** 3 to 5 years at 20°C (68°F)
  - CYCLE USE (approx.):**
    - 100% depth of discharge 200 cycles
    - 50% depth of discharge 500 cycles
    - 30% depth of discharge 1000 cycles
- **SEALED CONSTRUCTION:** Can be operated in any position without leakage.
- **STANDARD TERMINAL:** .250 Terminal or Optional M5 Bolt
- **HOUSING MATERIAL:** ABS Resin
- **OPTIONAL:** Container and cover made from Flame Retardant ABS (UL94-V0/L.O.I.>28%)

**Terminals**

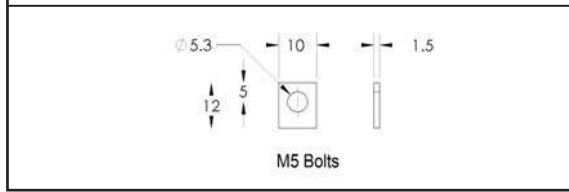
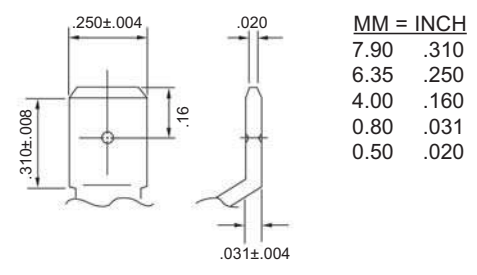

**Dimensions**

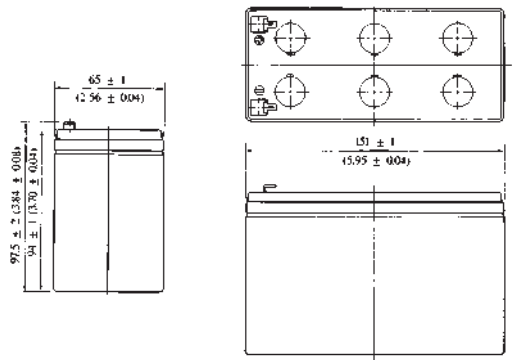

DIMENSIONS: MM (INCHES)  
\*Bolt height 106 ± 1 (4.17 ± 0.04)



### DISCHARGE CHARACTERISTIC CURVES AT 25°C (77°F)

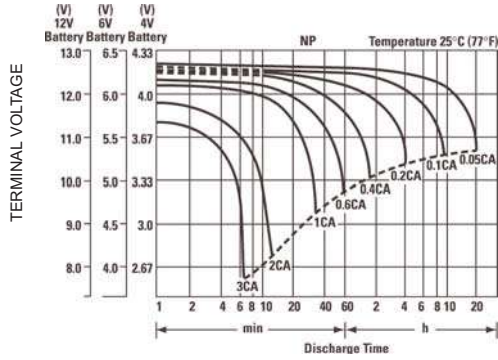

### TEMPERATURE EFFECTS IN RELATION TO BATTERY CAPACITY

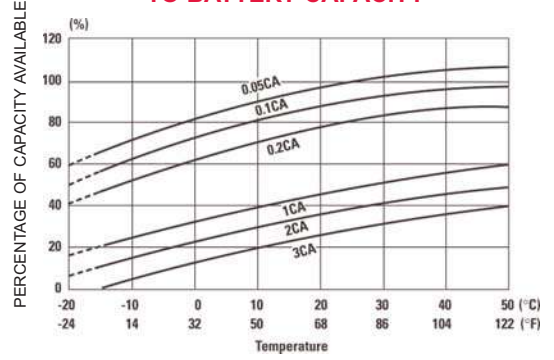

### SELF DISCHARGE CHARACTERISTICS

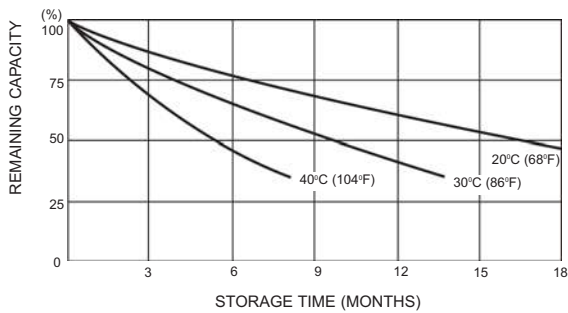

### OPEN CIRCUIT VOLTAGE VS REMAINING CAPACITY

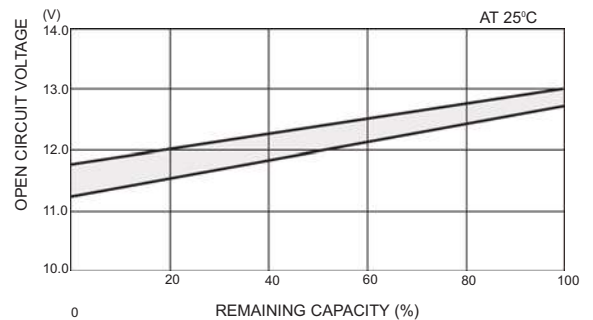

### CYCLE SERVICE LIFE IN RELATION TO DEPTH OF DISCHARGE

TESTING CONDITIONS: DISCHARGE CURRENT: 0.17C AMP. (F.V. 1.7V/CELL)  
 CHARGING CURRENT: 0.09C AMP.  
 CHARGING VOLUME: 125% OF DISCHARGED CAPACITY  
 AMBIENT TEMPERATURE: 20°C TO 25°C (68°F TO 77°F)

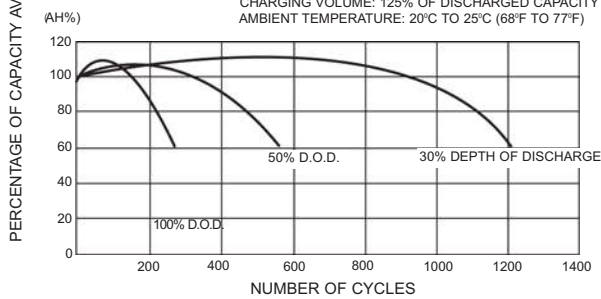

### FLOAT SERVICE LIFE

TESTING CONDITIONS: FLOATING VOLTAGE 2.25 TO 2.30V/CELL  
 AMBIENT TEMPERATURE: 20°C TO 22°C (68°F TO 72°F)



When the battery will be used by current in excess of 3C, consult with EnerSys prior to use.

#### CHARGING METHODS (At 20°C)

**Cycle use:** Maximum charging current 1.75A  
 Charging voltage 14.4 to 15.0V

#### CAUTION

- Avoid short circuit
- Do not charge in a sealed container.

**Standby use:** Float charging voltage 13.50 to 13.80V



Dirección: Av. Valle de Santiago N°27 Col. Valle de Aragón 1ª Secc Nezahualcóyotl Edo de Mèx. C.P.57100

Tèlèfonos: (55) 50620700 (55) 57120939/ 57120329

Tienda Online. [www.tiendaisso9000.com](http://www.tiendaisso9000.com)